



INDUSTRY PROVEN TRUSTED SOLUTIONS

Portable Metrology Solutions

SOLVING COMPLEX 3D MEASUREMENT CHALLENGES

We bring new frontiers to light

Part of AMETEK, Creaform is a proud leader in developing and manufacturing breakthrough 3D measurement and scanning solutions for thousands of clients worldwide. As the pioneer of the handheld 3D scanner, Creaform has redefined the boundaries of metrology and continues to push the limits of scanning technology, setting new industry standards.

This innovative spirit matches our commitment to solving our clients' most complex challenges, driving us to continually refine our technology, raise expertise, and prioritize their needs. Guided by this engagement, we empower manufacturing companies to elevate quality, maximize productivity, and accelerate time to market.

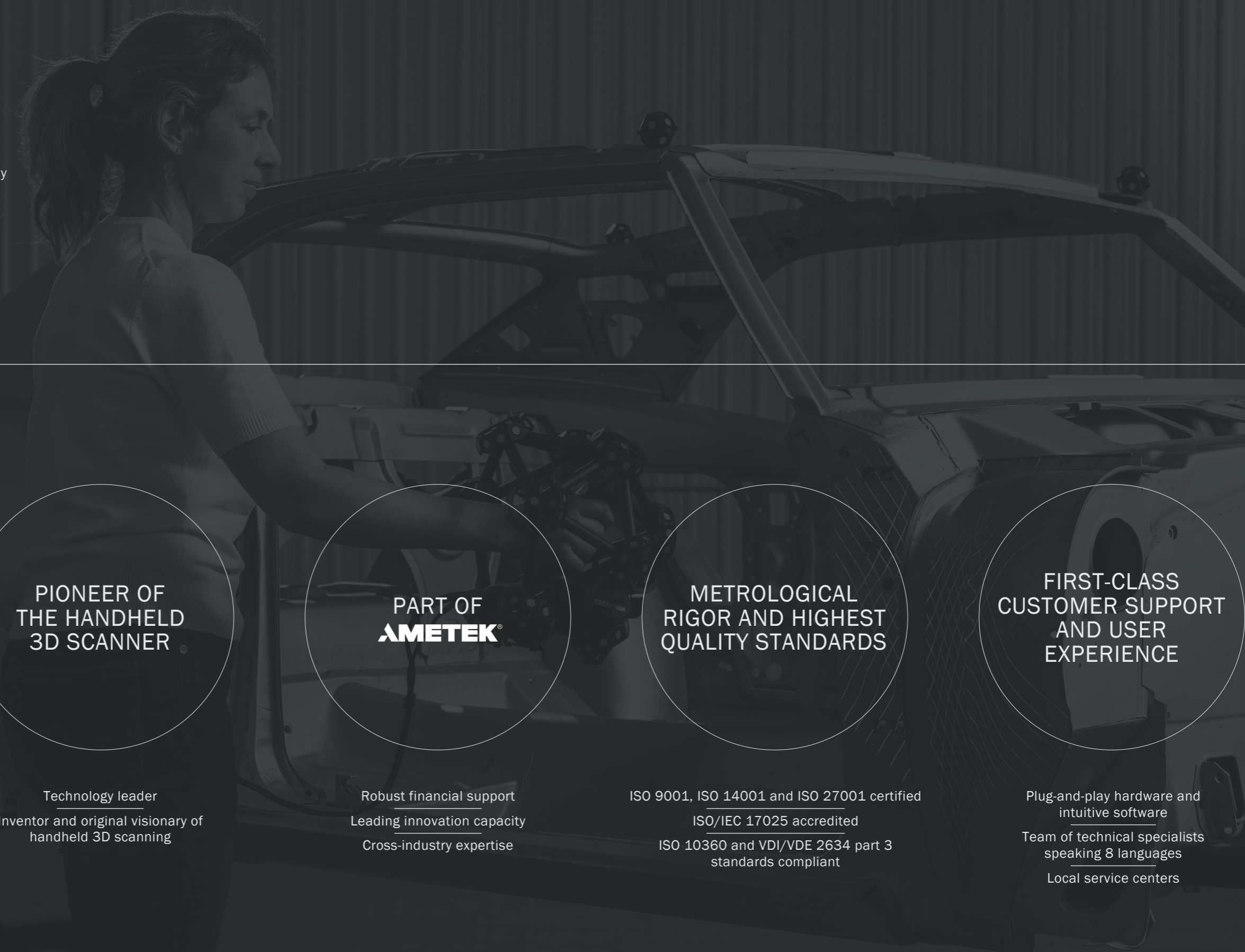

**FIELD-TESTED,
CLIENT-TRUSTED
SOLUTIONS**

**PIONEER OF
THE HANDHELD
3D SCANNER**

**PART OF
AMETEK®**

**METROLOGICAL
RIGOR AND HIGHEST
QUALITY STANDARDS**

**FIRST-CLASS
CUSTOMER SUPPORT
AND USER
EXPERIENCE**

Over 20 years of experience
More than 10,000 satisfied clients,
including major industrial OEMs

Technology leader
Inventor and original visionary of
handheld 3D scanning

Robust financial support
Leading innovation capacity
Cross-industry expertise

ISO 9001, ISO 14001 and ISO 27001 certified
ISO/IEC 17025 accredited
ISO 10360 and VDI/VDE 2634 part 3
standards compliant

Plug-and-play hardware and
intuitive software
Team of technical specialists
speaking 8 languages
Local service centers



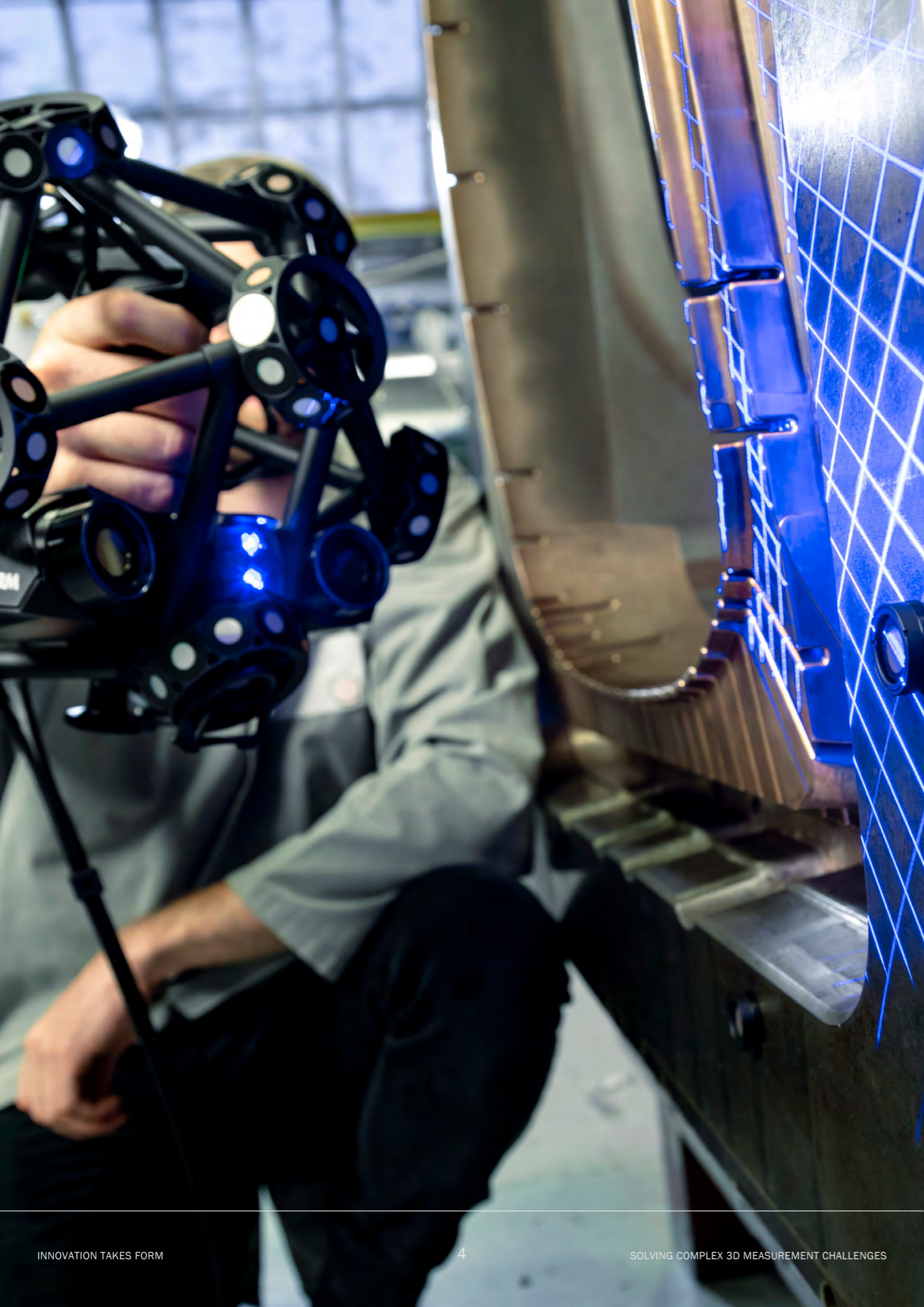

Content

PRODUCT DEVELOPMENT	06
QUALITY CONTROL	08
PORTFOLIO	10
HARDWARE	12
SOFTWARE	16
CUSTOMER SERVICE	18

Creaform's Approach to Product Development

In product development, engineers and designers often create comprehensive 3D models from existing objects ready for manufacturing, simulation, and 3D printing. This involves key steps like 3D scanning and 3D modeling. Creaform provides all the essential tools to streamline the entire reverse engineering process, accelerating time to market and giving companies a competitive edge.

With integrated solutions combining 3D scanners and innovative software platforms, Creaform delivers all the necessary information to develop new parts accurately and efficiently on the first try, eliminating multiple trial-and-error iterations and reducing the processing time required to integrate 3D models into CAD software.

In action



Save hours integrating physical objects into your product designs.

Not only is it easier to clean and align scan data and extract hole locations, complex surfaces, or any 2D and 3D measurements, but it also transfers richer information parametrically into CAD software, optimizing the time from scan to CAD with ready-to-use data.



Transform 3D scans into CAD models with ease.

Integrating data acquisition and feature extraction into a single, intuitive platform enables product designers to learn just one interface, streamlining software adoption and making reverse engineering accessible to all. This efficiency enables design teams to develop higher-quality products in fewer iterations.



Simplest and Most Intuitive 3D Scanning Solutions

Our integrated hardware and software provide users with the most intuitive, easy-to-use experience.



Complete & Integrated Software Application Suite

The Creaform Metrology Suite™ includes industry-leading Scan-to-CAD and Inspection application modules.

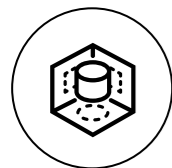

Fastest Time to CAD or Ready Data

Our Scan-to-CAD software module ensures the fastest path to CAD, 3D print, or usable data.

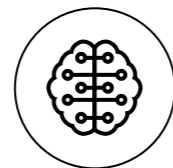

Evolutive 3D Scanning Solutions

Our 3D solutions deliver long-term value through continuous algorithm optimization and new feature additions.

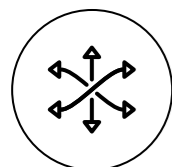

Most Versatile 3D Scanning Technology

Our superior 3D scanning algorithms and blue laser technology allow measuring any surface type.

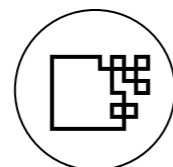

Highest Quality 3D Scan Data

Our high-resolution 3D scanners extract superior mesh quality with the finest details.

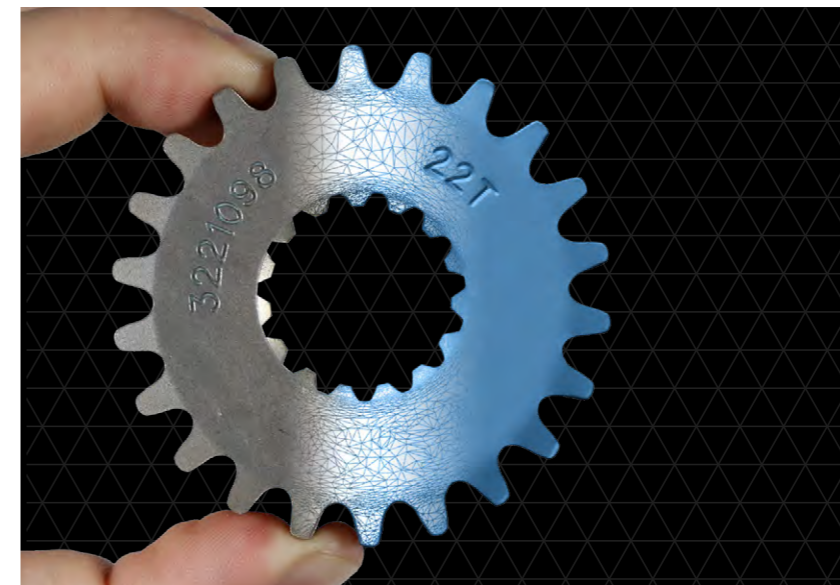

Capture 3D scan data with fine precision.

High-resolution 3D scanning systems capture high-quality 3D scan data, enabling the software to create meshes with finer details of intricate features. This allows product designers to develop parts that fit and function seamlessly with existing components, reducing iteration cycles during the design phase.



Capture shiny surfaces without extra steps.

Blue laser technology offers superior performance and delivers better readings of difficult, contrasted surfaces, providing the ability to master any surface type, including shiny, oily, and reflective finishes, without requiring surface treatment or part preparation.



Creaform Helps Solve Quality Control Issues

In quality control, quality professionals need reliable results they can trust. Only then can they make informed decisions to address their manufacturing challenges. Creaform's portable metrology solutions enable professionals to confidently validate the quality of manufactured parts without questioning the reliability of their measuring devices.

Creaform is ISO 9001 and ISO 14001 certified, reflecting our commitment to the highest quality standards. Our metrological rigor is further assured through ISO/IEC 17025 accreditation for our in-house laboratory, alongside compliance with ISO 10360 and VDI/VDE 2634 part 3 standards, ensuring verifiable and trusted specifications that meet the industry's strictest requirements.

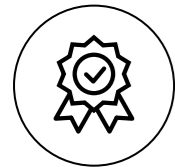

Reliable Metrology-Grade Accuracy

Our commitment to metrological rigor is demonstrated through the most notorious quality accreditations.



Highest Accuracy for Handheld 3D Scanners

Our HandySCAN BLACK+™ | Elite Limited delivers the best accuracy on the market for a handheld 3D scanner.

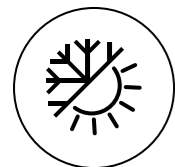

True Shop-Floor Accuracy

Our Dynamic Tracking algorithms allow for the most accurate 3D measurements in any environment.



Fastest Time to Usable Data or Reporting

Our inspection software displays the best fit with CAD in just three quick clicks (scan, align, colormap).



Highest Quality 3D Scan Data

Our high-resolution 3D scans enhance the detection of defects, deviations, and surface imperfections.

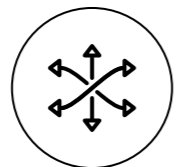

Most Versatile 3D Scanning Technology

Our superior algorithms and blue laser technology have rendered powder application irrelevant and outdated.

In action

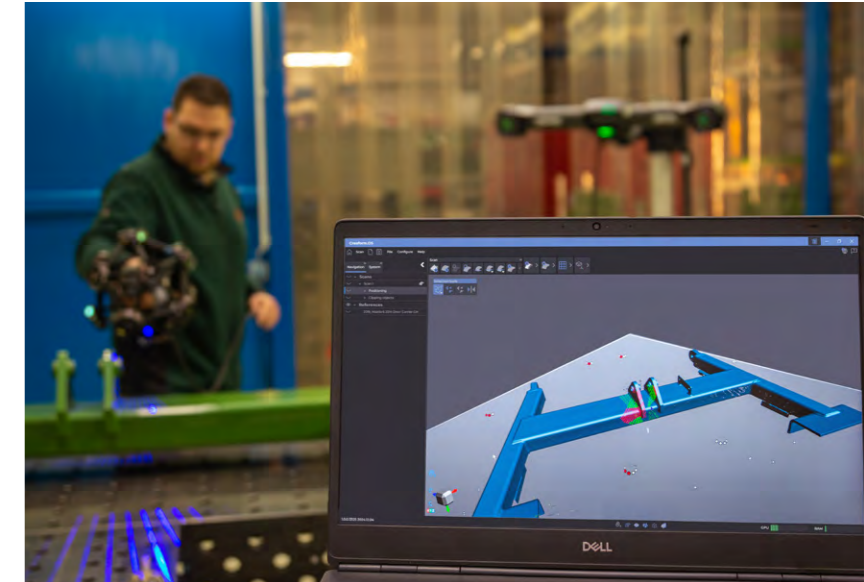

Rely on your 3D scanners, built to the highest quality standards.

Our commitment to metrological rigor is demonstrated through our 20 years of experience, our state-of-the-art manufacturing and development center located in Canada, and our global team of multi-disciplinary experts, ensuring every Creaform 3D system meets the highest industry standards.

Accelerate your inspections with instant reports.

Integrating the acquisition and application modules into a single platform and adding automatic functionalities, such as feature extraction and automatic best-fit, ensure the fastest path to reporting or usable data.



Ensure compliance and quality with trusted, accredited accuracy.

Accuracy is more than a number mentioned on a specification sheet. It is the indicator of the manufacturer's seriousness and commitment to quality. It reveals the level of technical expertise, knowledge, and proficiency it may possess to develop and produce high-quality and reliable measuring instruments.



Get the most accurate 3D measurements wherever you need them.

The metrology-grade attributes of our 3D scanning devices, combined with the surprising effectiveness of targets, allow manufacturers to accurately measure anything anywhere, regardless of environmental instabilities, and achieve consistent, reliable results anytime.



Product Offering

Complete Portfolio, Elevated Experiences

Through a forward-thinking approach and innovation-led solutions, Creaform tackles the real-world dimensional measurement challenges that prevail across various industries in product development and quality control applications.

Our product offering, which integrates both state-of-the-art hardware and advanced software, provides lasting solutions that evolve with industry needs. Together, these integrated solutions deliver the portable metrology capabilities that our customers need to excel in every aspect of their work.



HARDWARE
HARDWARE



SOFTWARE
SOFTWARE

Hardware Portfolio

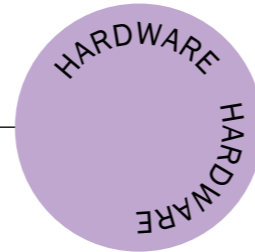

Portability takes form

With their legendary portability, proven ease of use, powerful dynamic referencing algorithm, and metrology-grade accuracy, Creaform's 3D measuring devices have reshaped 3D metrology by redefining the limits of innovation.

As the pioneer of the handheld 3D scanner, Creaform has made it possible to take this impressive measurement capability beyond metrology labs and allow a wider range of users to benefit from it.

Acquisition Platform Included with All 3D Scanners

Creaform.OS is a powerful, integrated operating software that ensures seamless hardware-software synergy during acquisition, delivering an unparalleled 3D measurement experience.

Portable 3D Scanning Solutions

Our pioneering portable 3D scanners can be used anywhere while maintaining exceptional accuracy.

True Shop-Floor Accuracy

The one & only Dynamic Tracking algorithm allows for the most accurate and rigorous 3D measurements in any environment.

Sleek Ergonomic Designs

With their perfect blend of ergonomics and sleek design, Creaform 3D systems feel like high-end tools built right into the customer's hand.

Industry Proven & Trusted Solutions

With over 20 years of experience, the Creaform brand is synonymous with worry-free investment.

The Ideal 3D Scanners Designed Around Your Needs



HandySCAN 3D™ | BLACK Series

The Industry Standard for Portable Metrology-Grade 3D Scanners



MetraSCAN 3D™

The Fastest and Most Accurate Portable CMM for the Shop Floor



HandySCAN 3D™ | SILVER Series

The Most Accessible and Trusted Professional 3D Scanners



HandyPROBE™

The Proven Portable Optical CMM for the Shop Floor



HandySCAN 3D™ | MAX Series

The Most Reliable Portable Metrology-Grade 3D Scanners for Large Parts



MaxSHOT 3D™

The Most Accurate Optical CMM for Photogrammetric Applications



Go!SCAN 3D™

The Fastest and Easiest 3D Scanner for Color Acquisition



Accessories Designed to Elevate User Experience



Accu+ Kit

Scale bar kit to achieve superior volumetric accuracy performance with the HandySCAN BLACK+ |Elite



Magnetic 360° targets

Reusable, easy to set up, auto-detected by the HandySCAN 3D, and software-removed

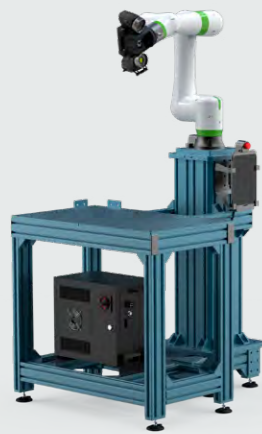

Automation Kit

Comprehensive turnkey solution for automating the HandySCAN 3D and MetraSCAN 3D



Workstation

Flexible station designed to facilitate mobility across the production floor

Technical Specifications

	GoSCAN 3D™	HandySCAN 3D™		HandySCAN MAX™ Elite	MetraSCAN 3D™	HandyPROBE™	MaxSHOT 3D™	
	GoSCAN SPARK™	HandySCAN SILVER™ Elite	HandySCAN BLACK™ Elite	HandySCAN MAX™ Elite	MetraSCAN BLACK™ Elite	HandyPROBE Next™ Elite	MaxSHOT NEXT™ Elite	
PART SIZE RANGE (recommended)	0,1-4 m	0,05-4 m	0,05-4 m	1-15 m	0,2-6 m	0,25-6 m	2-10 m	
ACCURACY	Up to 0.050 mm	Up to 0.030 mm	0.025 mm	0.075 mm	0.025 mm	0.025 mm	N/A	
VOLUMETRIC ACCURACY (based on working volume)	9.1 m ³ 16.6 m ³	N/A	N/A	N/A	0.064 mm 0.078 mm	0.064 mm 0.078 mm	N/A	
VOLUMETRIC ACCURACY (based on part size)	0.050 mm + 0.100 mm/m	0.020 mm + 0.060 mm/m	0.020 mm + 0.040 mm/m 0.020 mm + 0.015 mm/m ⁽²⁾ 0.012 mm + 0.015 mm/m ^(2,3)	0.075 mm + 0.010 mm/m	0.025 mm + 0.015 mm/m ⁽⁴⁾	0.025 mm + 0.015 mm/m ⁽⁴⁾	0.015 mm/m	
ACCEPTANCE TEST ⁽⁵⁾	Internal procedure	Internal procedure	Based on VDI/VDE 2634 part 3 and ISO 10360	Based on VDI/VDE 2634 part 3	Based on VDI/VDE 2634 part 3 and ISO 10360	Based on ISO 10360	Based on VDI/VDE 2634 part 1	
VOLUMETRIC ACCURACY WITH MaxSHOT NEXT™ Elite ⁽⁶⁾	0.050 mm + 0.015 mm/m	0.020 mm + 0.015 mm/m	0.020 mm + 0.015 mm/m	N/A	0.025 mm + 0.015 mm/m	0.025 mm + 0.015 mm/m	0.015 mm/m	
MEASUREMENT RESOLUTION	0.100 mm	0.030 mm	0.025 mm	0.040 mm	0.025 mm	0.025 mm	0.015 mm	
MESH RESOLUTION	0.200 mm	0.200 mm	0.100 mm	0.400 mm	0.100 mm	0.100 mm	0.015 mm	
SCANNING AREA	390 x 390 mm	310 x 350 mm	310 x 350 mm	1000 x 1000 mm	310 x 350 mm	310 x 350 mm	0.015 mm	
STAND-OFF DISTANCE	400 mm	300 mm	300 mm	1000 mm	300 mm	300 mm	0.015 mm	
DEPTH OF FIELD	450 mm	250 mm	550 mm	2200 mm	250 mm	250 mm	0.015 mm	
LIGHT SOURCE ⁽⁷⁾	White light (99 stripes)	14 blue laser lines (+ 1 extra line)	30 blue laser lines (+ 1 extra line)	38 blue laser lines	30 blue laser lines (+ 1 extra line)	30 blue laser lines (+ 1 extra line)	0.015 mm	
MEASUREMENT RATE	1,500,000 measurements/s	800,000 measurements/s	1,800,000 measurements/s	2,250,000 measurements/s	1,800,000 measurements/s	1,800,000 measurements/s	0.015 mm	
WEIGHT	1.25 kg	0.94 kg	0.94 kg	1.22 kg	Scanner: 1.49 kg C-Track: 5.7 kg	Scanner: 1.49 kg C-Track: 5.7 kg	0.79 kg	
DIMENSIONS (LxWxH)	89 x 114 x 346 mm	79 x 142 x 288 mm	79 x 142 x 288 mm	133 x 79 x 435 mm	Scanner: 289 x 235 x 295 mm C-Track: 1031 x 181 x 148 mm	Scanner: 289 x 235 x 295 mm C-Track: 1031 x 181 x 148 mm	104 x 180 x 115 mm	
OPERATING TEMPERATURE RANGE	5-40 °C	5-40 °C	5-40 °C	5-40 °C	5-40 °C	5-40 °C	5-40 °C	
OPERATING HUMIDITY RANGE (non-condensing)	10-90%	10-90%	10-90%	10-90%	10-90%	10-90%	10-90%	
CERTIFICATIONS	EC Compliance (Electromagnetic Compatibility Directive, Low Voltage Directive), compatible with rechargeable batteries (when applicable), IP50, WEEE	EC Compliance (Electromagnetic Compatibility Directive, Low Voltage Directive), compatible with rechargeable batteries (when applicable), IP50, WEEE	EC Compliance (Electromagnetic Compatibility Directive, Low Voltage Directive), compatible with rechargeable batteries (when applicable), IP50, WEEE	EC Compliance (Electromagnetic Compatibility Directive, Low Voltage Directive), compatible with rechargeable batteries (when applicable), IP50, WEEE	EC Compliance (Electromagnetic Compatibility Directive, Low Voltage Directive), compatible with rechargeable batteries (when applicable), IP50, WEEE	EC Compliance (Electromagnetic Compatibility Directive, Low Voltage Directive), compatible with rechargeable batteries (when applicable), IP50, WEEE	EC Compliance (Electromagnetic Compatibility Directive, Low Voltage Directive), compatible with rechargeable batteries (when applicable), IP50, WEEE	EC Compliance (Electromagnetic Compatibility Directive, Low Voltage Directive), compatible with rechargeable batteries (when applicable), IP50, WEEE

(1) The volumetric accuracy (based on part size) performance of the system cannot be superior to the default Accuracy and Volumetric accuracy (based on working volume) performance for a given mode.
 (2) Performance obtained with scale bars included in the Accu+ Kit.
 (3) Performance obtained with Limited Edition. Limited Edition is able to deliver improved accuracy through optimized manufacturing and calibration processes.
 (4) Performance obtained with the Automatic Volume Extension feature.
 (5) Performance tests done in Creafom's ISO/IEC 17025 accredited calibration laboratories.
 (6) The volumetric accuracy with MaxSHOT NEXT™|Elite performance cannot be superior to the default Accuracy and Volumetric accuracy (based on working volume) performance for a given mode.
 (7) Laser class: 2M (eye safe).



Software Portfolio

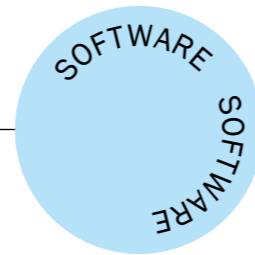

Simplicity takes form

The Creaform Metrology Suite offers a complete portfolio of software modules tailored for metrology applications, including reverse engineering, inspection, dynamic tracking, and digital twin generation.

The Creaform Metrology Suite includes two dedicated application software modules—Scan-to-CAD and Inspection—developed specifically for product development and quality control, providing a comprehensive and integrated solution to real-world challenges.

Intuitive Software for Optimal User Experience

With its intuitive interface and streamlined tools, the Creaform Metrology Suite enhances user experience and optimizes workflows.

Smart Features for Seamless Operation

Features like smart resolution, automatic shutter, live meshing, and AI-driven target detection reduce software complexity and minimize device interaction.

Self-Onboarding & e-Trainings Modules

Our continually expanding library of e-training modules simplifies onboarding and empowers users to work faster, smarter, and with greater accuracy.

Private & Secure Data

Creaform's robust data privacy and cybersecurity measures ensure that 3D data integrity remains secure and trustworthy.

Streamline your workflow with the Creaform Metrology Suite

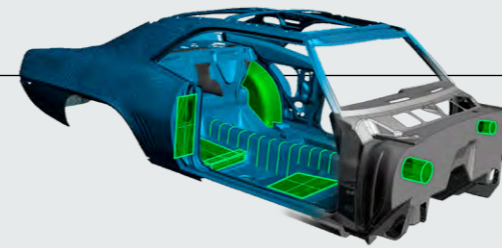

Scan-to-CAD

The most intuitive reverse engineering toolkit for transferring 3D scan data into any CAD platform.

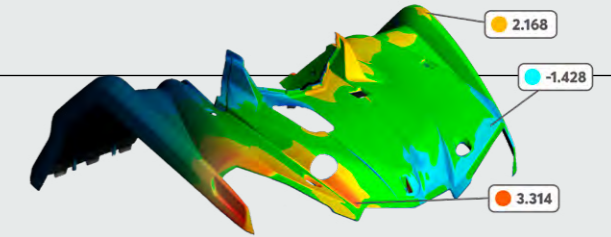

Inspection

The most flexible, comprehensive, and easy-to-use software solution for part inspection.

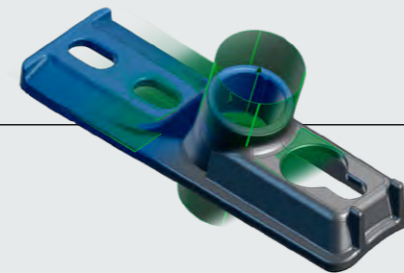

Scan-to-CAD Pro

The easiest-to-use reverse engineering suite for feature extraction and CAD modeling from 3D scan data.

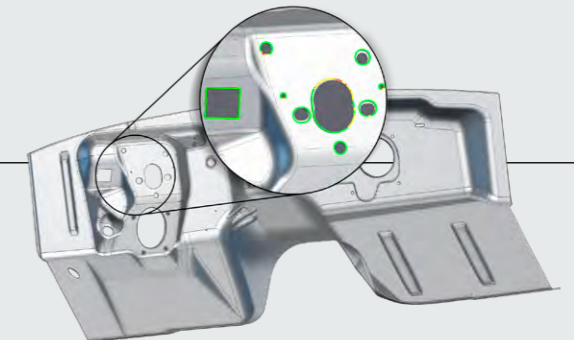

Inspection - Sheet Metal Add-on

The most repeatable and accurate 3D measurement inspection module for sheet metal.

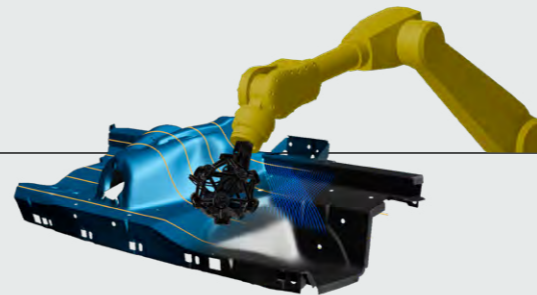

Automation

The most user-friendly digital twin environment for deploying automated quality control solutions.



Dynamic Tracking

The most accurate and repeatable tool for tracking multiple objects in time and space.



Customer Service



Partnership takes form

From day one, Creaform partners with its clients, guiding them through a seamless onboarding experience. Our customer-driven and solution-focused team provides continuous support and valuable resources, ensuring users maximize their 3D scanning journey. As client needs evolve, we consistently enhance our offerings, delivering lasting, future-ready solutions that tackle manufacturing challenges head-on.

By Your Side Through the Complete Journey



- Platform Designed to Streamline Onboarding for New Users
- Intuitive Interface, User-Friendly Tools
- Continually Expanding Library of e-Training Modules

- Plug-and-play Hardware and Software Seamlessly Integrated
- Smart Features for Enhanced User Experience and Optimized Workflows
- Proficient, Multilingual Customer Support

- Regular Addition of New, Innovative Features
- Constant Optimization of Sophisticated Algorithms
- Access to a Vast Network of Service Centers Worldwide



Partner with us for your next challenges

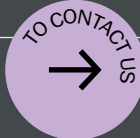

For an unparalleled experience connect with us
at the nearest office located in Germany.

creaform3d.com